

A Study on Strengthening the Role of Local  
Government in Job Creation

**2009. 12**

## 연구진

서정섭(연구위원)

이창균(선임연구위원)

이 보고서의 내용은 본 연구진의 견해로서  
한국지방행정연구원의 공식 견해와는 다를 수도 있습니다.





,

,

.

가

,

4가

.

,

.

,

가 가

.

,

.

,

가

,

-

가

.

가

,

,

,

.

,

가

.

.

가 .

, 가 . , 가 .

, 가 가 . 가 .

가 . 가 ,  
가 . ,  
, , 가

Buy Local

가 . , .

.  
. 가 . 가  
가 ,  
가  
. , ,  
가 .  
가 , .  
가  
가 . DB  
. 가 DB  
. , , DB  
가 .



1	.....	1
1	.....	1
2	.....	3
2	.....	5
1	.....	5
1.	.....	5
2.	.....	8
2	.....	10
1.	.....	10
2.	.....	12
3.	.....	14
4.	.....	15
3	.....	17
1.	.....	17
2.	.....	20
3.	.....	23
4.	.....	40
5.	.....	45
3	.....	47
1	.....	47
1.	.....	47
2.	.....	49

---

2	.....	55
1.	(09 -12 ) .....	55
2.	: 2009 .....	60
3.	.....	65
4.	.....	68
5.	.....	71
6.	: .....	76
3	가 .....	80
1.	가 .....	80
2.	.....	90
4	.....	94
1	.....	94
2	.....	97
1.	.....	97
2.	.....	98
3	.....	101
1.	.....	101
2.	.....	108
3.	.....	111
4.	.....	113
4	.....	116
1.	.....	116
2.	.....	118
3.	.....	123
4.	.....	125
5	.....	126
1.	.....	126
2.	.....	128
3.	.....	129



---

5	.....	130
1	.....	130
2	.....	132
	.....	136
Abstract	.....	139



< 2-1> : OECD .....7

< 2-2> .....11

< 2-3> ( ) .....14

< 2-4> .....19

< 2-5> 2009 .....20

< 2-6> .....24

< 2-7> 2009 .....31

< 2-8> .....32

< 2-9> 2008 「 」 .....35

< 2-10> 「 」 .....42

< 2-11> 市州 歐州 .....43

< 3-1> .....48

< 3-2> .....50

< 3-3> .....50

< 3-4> ( ) .....51

< 3-5> ( ) .....52

< 3-6> .....53

< 3-7> .....54

< 3-8> 2009~2012 ( ) .....56

< 3-9> , .....57

< 3-10> 2009~2012 .....58

< 3-11> 2009 .....61

< 3-12> 「 」 .....63

< 3-13> 「 」	.....	64
< 3-14>	.....	66
< 3-15>	.....	67
< 3-16>	.....	69
< 3-17>	( )	.....74
< 3-18> , , , ,	( )	.....74
< 3-19>	(2009 )	.....77
< 3-20> 가	.....	80
< 3-21>	.....	81
< 3-22> 16	(2000~2006)	.....85
< 3-23>	.....	86
< 3-24>	.....	88
< 3-25>	.....	89
< 3-26>	:	.....91
< 3-27>	:	.....93
< 4-1>	가	.....99
< 4-2>	가	.....101
< 4-3>	.....	102
< 4-4>	가	.....107
< 4-5> OECD	.....	109
< 4-6>	가	.....116
< 4-7>	.....	118
< 4-8>	(SSBG) 가	.....119
< 4-9>	(SSBG)	.....120
< 4-10>	.....	122
< 4-11>	.....	124
< 4-12> 2009	.....	124
< 5-1>	.....	134



< 1-1>	.....	4
< 2-1>	.....	6
< 2-2>	.....	10
< 2-3>	.....	16
< 2-4>	.....	18
< 2-5>	.....	34
< 3-1>	.....	50
< 3-2>	.....	62
< 4-1>	.....	96
< 4-2>	.....	104
< 4-3>	.....	106
< 4-4>	.....	114
< 4-5>	CB .....	114

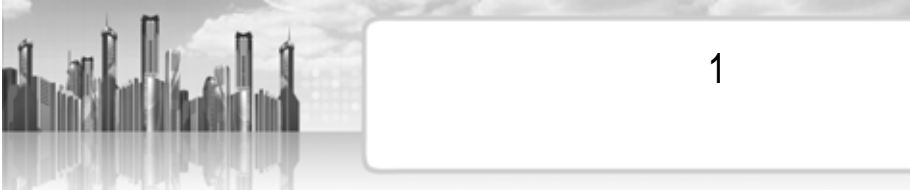

1



(jobless growth)

1990

가

가

가

가

가

( , 2006).

.1)

( , 2007).

2008

, 가 ,

( , )

( , )

, ,

1)

2004 2006

2008

,  
 ,  
 .  
 . OECD  
 . (Bennett & Krebs)  
 ,  
 가  
 ,  
 ( , 2002:60-61). 가 가 가  
 .  
 ,  
 가  
 . 가 가 가  
 .  
 2)  
 가  
 ,  
 ,  
 ,  
 ,  
 ,  
 ,

---

2)  
 (1998), (2002), (2007), (2008)  
 , , 3

가 .

,

,

가

가 .

,

,

.

2



,

,

,

,

,

.

가

가

.

,

,

,

.

< 1-1 >

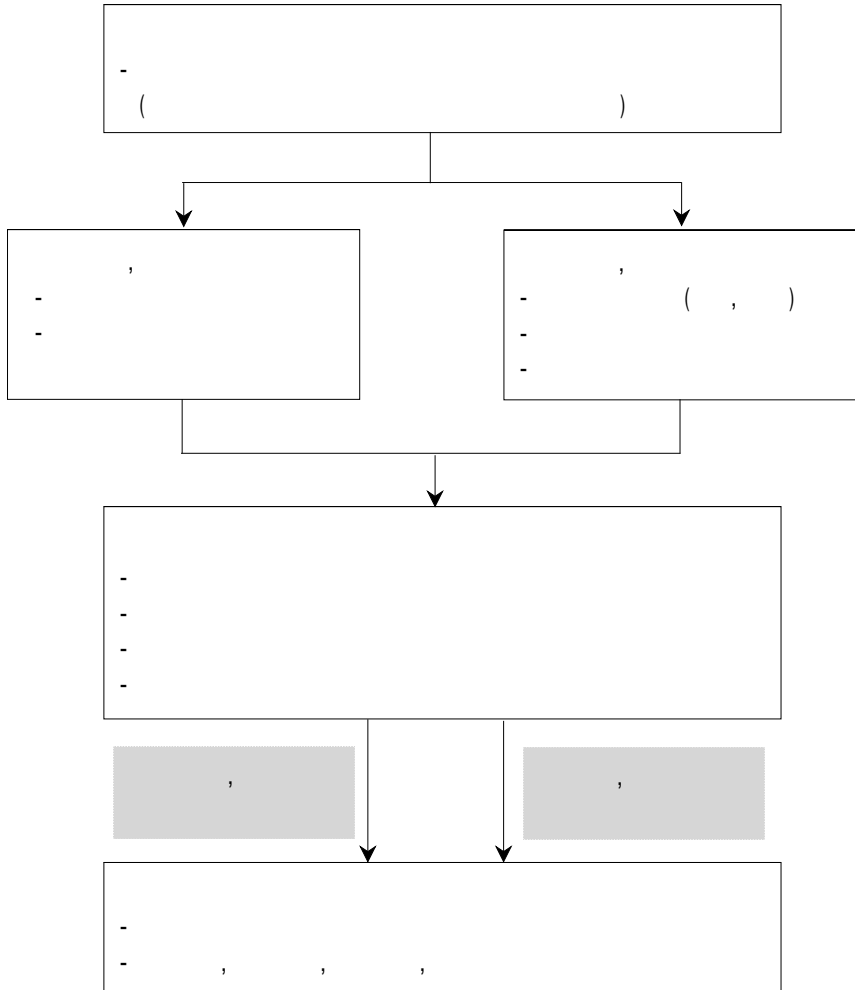



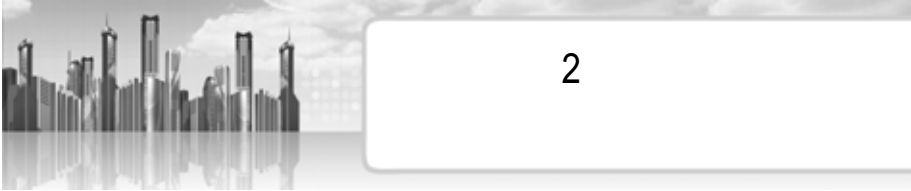

1



### 1. 일자리의 개념과 일자리창출 사업의 분류

(job)

(work,

task, position, business, employment, venture, duty, assignment, calling, field ect.)

(雇用,

employment)

(job have been)

(created or saved)

( )

10,000

(created)

10,000

(saved)

10,000

, 10,000

가

10,000

가

(forbes, 2009.6.8).

( , 2006:15).

2004 2006  
( ,  
2006:6).

가  
(Active Labor Market Policy)  
(Passive Labor Market Policy)  
가  
가  
가

< 2-1>

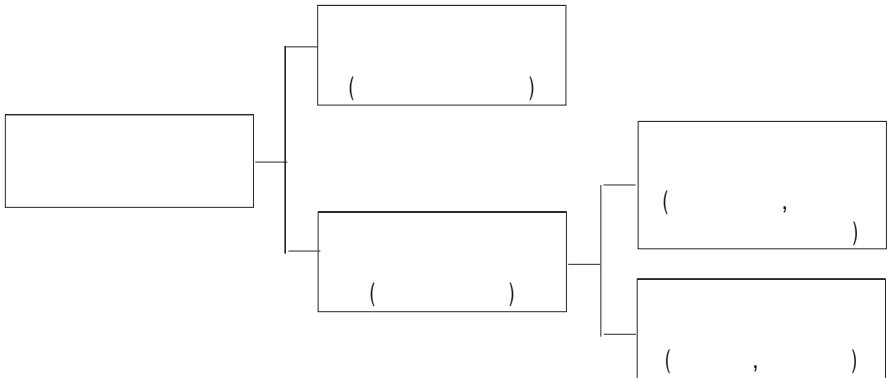

OECD , , , , , . ( , 2006 ; , 2006). OECD가 (Active Labor Market Policies) , , . (employment service), (vocational training), . OECD가 < 2-1> . OECD , , , . ( , 2007:98).

< 2-1>

: OECD

(Active measures)	(Public employment service and administration)	-
		-
		- DB
	(Labor market training)	-
		-
	(Youth measures)	-
-		

< >

(Active measures)	(Subsidised employment)	-
	(Measures for the disabled)	-
(Passive measures)	(Unemployment ompensation)	-
	(Early retirement for labor market reasons)	-

: OECD, Employment Outlook, 2006( , 2007:98).

## 2. 일자리 창출 관련 재정지원

(target group) ( , 2006:16-19).

가 , (public) (non-profit) ,

가

가 , , , , , 가 가

가 가

.

.

가

,

,

,

,

.

,

6가

가 가

.

.

가

.

.

.

.

.

,

,

,

,

.

.

< 2-2>

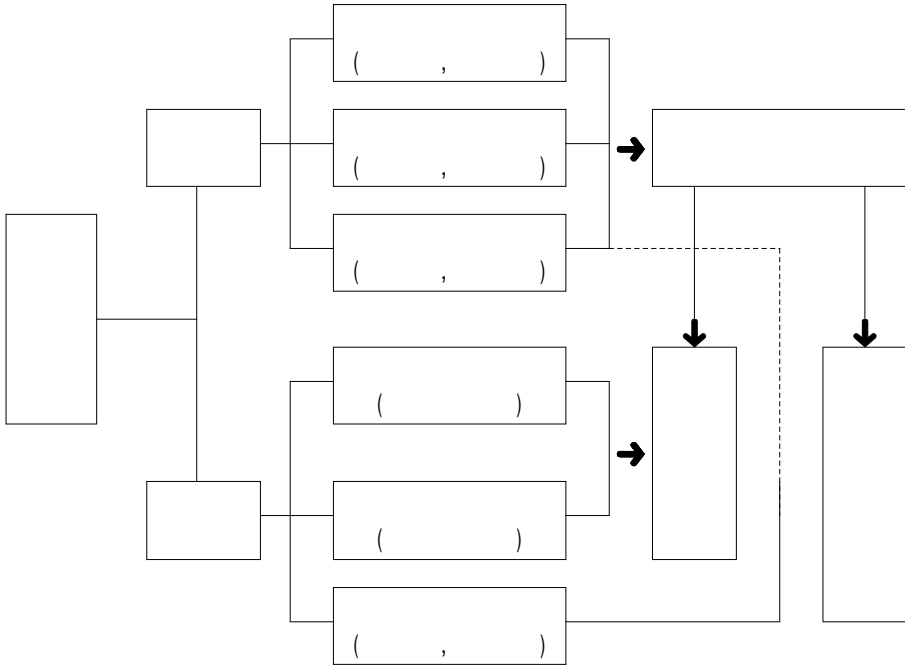

: (2006 : 18).

## 2

### 1. 기능 및 재정분권화 측면

Shah(1994)

## &lt; 2-2&gt;

		/ /		/			
		中		中			
		中		中			
		中		中			
	/ /	中		中			
		中		中			
		中		中			
		中		中			
		中		中			
	.	中		中			
		中, 廣		中, 廣, 基			가
		中		中, 廣, 基			
		中		中, 廣, 基			
		中, 廣, 基		廣, 基			
		中, 廣, 基		廣, 基		가	
		中, 廣, 基		廣, 基		가	
		中, 廣, 基		廣, 基		가	
	/	廣, 基		廣, 基			
		基		基			
	/	中, 廣, 基		中, 廣, 基			( 가, 가 )
		中					
		廣		廣, 基			
		廣		廣, 基			
		基		廣, 基			

: 中 , 廣 : , 基 :

: Shah, Anwar, The Reform of Intergovernmental Fiscal Relations in Developing and Emerging Market Economy, Washington D.C.: The World Bank, 1994( (1997) ).

, 가  
 , , ,  
 가  
 ,  
 가 , 가  
 가 , 가  
 , 가  
 ,  
 ,  
 . Oates(1993: 240-242)  
 , 가  
 , 가  
 가 ,  
 , 가 가  
 , 가

## 2. 재정의 역할 측면

R.A.Musgrave(1959)

(allocation function),



(distribution function),

(stabilization function) 3가

가

. E. Gramlich

. 1995 가 (GDP)  
 12.2% ) 가 ( )  
 , 2002 : 30).

2008 123.5 ( ,  
 ) GDP 1,023 12.1% 45.1%  
 . 가 가

가

가

### 3. 지역개발정책 수단 측면

가  
 가 , EU 가  
 , (Grants) 가  
 (loans and financial guarantees)  
 ,  
 ,  
 (disadvantaged region)  
 (regional policy instrument)

< 2-3> ( )

	(%)
1.	
(a)	29
(b)	12
(c)	14
(d) (relocation expenses)	15
(e)	14
(f)	15
(g) /	9
(h)	12
(i)	6
(j)	9
2.	23
3.	66
4.	70
5.	35
6.	5

	< > (%)
7.	10
8. (Enterprise Trust)	22
9.	13
10. (business advice)	48
11.	42
12.	43
13. 가	39
14.	60
15.	26
16.	46
17. ( ) 가	38
18.	12
19.	63
20. .	
(a)	41
(b) ( )	11
(c) ITECs	33
(d)	36
(d)	19

: (district council)

#### 4. 고용의 수요·공급 측면

. 가 . .  
 ( 가 ) ,  
 ,  
 가 .

< 2-3>

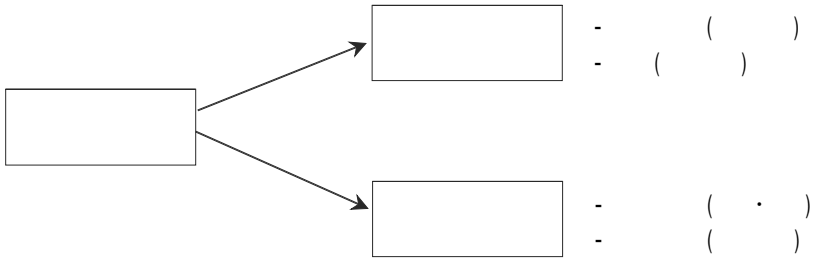

가

가

, . , , ,

.

,

, , . , ,

가

.

,

OECD 1990

.

가 .

가

가 가

가

가

.

3



### 1. 주요 선진국의 고용전략 변화

2008 9 가  
 가  
 . , , , ,  
 , ,  
 ( ,  
 2009:11-13).  
 ,  
 가 가  
 . 가  
 가 가 . ,  
 .

< 2-4>

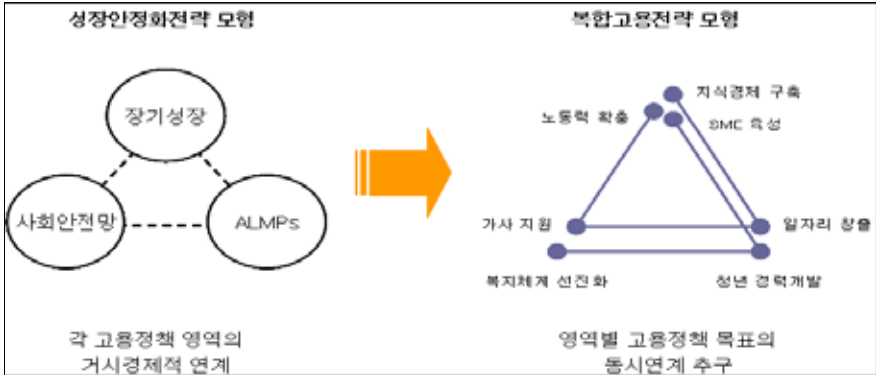

: (2009:12)

가 (< 2-4> ).

, + :

SOC ,

, .

가

, R&D

, .

, + :

가 , 가

. 2 24

가 .

, + + :

,

가

< 2-4 >

	<ul style="list-style-type: none"> <li>7890 ,</li> <li>300</li> <li>, IT</li> </ul>	<ul style="list-style-type: none"> <li>200</li> <li>, IT</li> <li>,</li> <li>가</li> </ul>	<ul style="list-style-type: none"> <li>260</li> <li>IT,</li> <li>,</li> <li>가</li> </ul>	<ul style="list-style-type: none"> <li>1000</li> <li>,</li> <li>R&amp;D</li> <li>,</li> <li>가</li> </ul>	<ul style="list-style-type: none"> <li>17</li> <li>,</li> <li>,</li> </ul>
EPL ( )		<ul style="list-style-type: none"> <li>(flexible working)</li> </ul>			
ALMPs ( )		<ul style="list-style-type: none"> <li>jobcentre plus</li> <li>,</li> </ul>	<ul style="list-style-type: none"> <li>,</li> <li>,</li> </ul>	<ul style="list-style-type: none"> <li>,</li> <li>,</li> </ul>	<ul style="list-style-type: none"> <li>,</li> <li>,</li> </ul>
		<ul style="list-style-type: none"> <li>(2008.5)</li> </ul>	<ul style="list-style-type: none"> <li>-</li> </ul>	<ul style="list-style-type: none"> <li>,</li> <li>,</li> <li>,</li> <li>,</li> </ul>	<ul style="list-style-type: none"> <li>가</li> <li>,</li> <li>,</li> </ul>

: (2009:14)

## 2. 미국 사례

(2009.1.20)

, , 2009.2.17  
 . ,  
 「 (American Recovery and Reinvestment Act of  
 2009) .

2011 250

,  
 .  
 .  
 .  
 ,  
 .  
 .

< 2-5> 2009

【           】	
(    )	



< >	
<b>【           】</b>	
	-
	-
	[            ]
	-                                 :         33
	-                                 :         25         (             300     )
	[            ]
	-             가   (medicaid)
	-                             가                             (Consolidated Omnibus
	Budget Reconciliation Act: COBRA)                         : 12     ,
	65%
<b>【           】</b>	
	(            ):
	4.9%p     ,             1.5%p     가
	가
	/            /
<b>【           】</b>	
	,

: 「   」(American Recovery and Reinvestment Act of 2009)

:                     (c)(2009 : 56)(             : Congressional Budget Office, Cost Estimate-American Recovery and Reinvestment Act of 2009, 2009. 1; Romer, C., & Bernstein, J, The Job Impact of the American Recovery and Reinvestment Plan)

2009   6   8   (6-8 ) 3                     600,000

(Roadmap to Recovery)   .                     10

.

: 50                     1,129                     -

,   (

21                    )                    )                    )  
                   가                    : 98                    1,500  
                   (                    ,                    )  
                   :                    ,                    ,                    135,000                    -  
                   ,                    (                    ,                    ,                    )  
                   )                    : 38                    90                    -  
                   (                    -  
                   ,                    ,                    ,                    )                    )  
                   가                    :                    5,000  
                   :                    200  
                   -                    : 107                    /                    -  
                   (                    )                    )  
                   ·                    ,                    ,                    ,                    ,                    ,  
                   ,                    ,                    ,                    ,                    ,  
                   ,                    6가                    )  
                   : 20                    Superfund(                    )  
                   site                    -                    ,  
                   ,                    ‘                    ,  
                   : 125,000                    - 600  
                   ,                    가                    : 359                    2,300



: Recovery Act 100 (2009.6.8 )

: White house(Roadmap to Recovery, June 2009)

### 3. 일본 사례

가.

“ . ”

(2008.12)

( (d), 2009:4-6).

206

“ ”

( ) . , ,

, , , , , , , ,

, , ( , , ),  
 10  
 206  
 , “ ” (2008 , 2,500 ,  
 3.4 ) 3 (2009 -2011 )

가

< 2-6>

	Flexible	,	- ,	- ,
			- ,	- ,



				<	>
		-		-	
		-		-	
	·	·	·	·	·
		-	가	-	가
		-		-	

				<	>
·	:	,	,	,	, IC
			-		-
			-	가	-
·	:	,	,	,	,
			,	, IC	, IC
			,	, IC	
	가				
	海)			가	(瀬戸内
			-		-
·	:	,	,	,	,







2009 , 가  
 1 .  
 5,000  
 .  
 [ ] ,  
 ,  
 2008 3  
 가 2008 12  
 19 [ ( ) ]  
 2008 2009 6  
 .

(1) , (2) , (3) ,
(4) , (5) , (6)

. 가 [ ]  
 ] [ ]  
 1 .  
 5,000 .  
 가 1  
 1 가  
 .

< 2-7> 2009

( : )

1.	146,987	1.	31,066
(1)	12,698	(1)	31,000
(2)	29,659	(2)	66
(3)	15,775		
(4)	20,221	2.	108,190
(5)	25,775	(1)	73,320
(6)	1,981	(2)	34,870
(7)	17,089		
(8)	23,790		
2.	768		
3.	8,500		
	139,256		139,256

## 2) 지역고용창출추진비의 신설

2009

[ ] .

2009 2010 5,000

[ ]

&lt; 2-8&gt;

( : , %)

	2009 (A)	2008 (B)	(A - B)=(C)	(C/B)
( )	361,860	404,703	42,843	10.6
	14,618	7,027	7,591	108.0
	4,620	4,735	115	2.4
	158,202	154,061	4,141	2.7
	103,016	100,831	2,185	2.2
	118,329	96,055	22,274	23.2
	15,859	16,220	361	2.2
	49,053	50,382	1,329	2.6
	825,557	834,014	8,457	1.0
	590,786	598,858	8,072	1.3
	209,688	182,393	27,295	15.0
( )	221,271	222,071	800	0.4
	192,408	194,447	2,039	1.0
	5,244	3,759	1,485	39.5
	23,619	23,865	246	1.0
	272,608	265,464	7,144	2.7
	122,887	115,660	7,227	6.2
	138,285	138,410	125	0.1
	11,436	11,394	42	0.4
	4,000	4,000	0	0.0
	5,000	-	5,000	가
	132,955	133,796	841	0.6
	9,678	9,680	2	0.0
	140,617	148,151	7,534	5.1
	59,809	64,844	5,035	7.8
	80,808	83,307	2,499	3.0
	26,628	26,352	276	1.0



(d)(2009 : 34-38).

(創意)

「 」 ,

< 2-5>

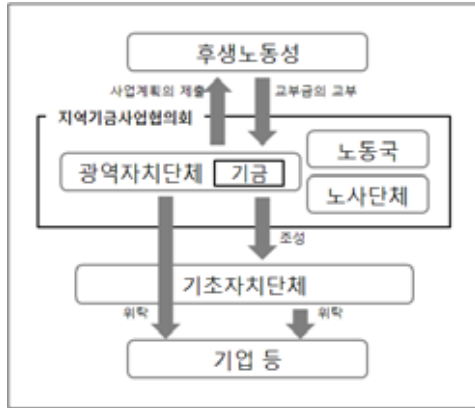

가  
가

,  
 ,  
 , ( 가)  
 , 1/2  
 , 1 , 가  
 ,

2,500 ( ) , 3  
 10 ,

< 2-9> 2008 「 」

( : )

1	가	1	4	가	4
1		1	1		3
1		1	1	2008 ) ( ,	2
2		1	8	가 , B·C 가 가	6

					<	>
3		1	8	가 가 ,		6
4	( )	2	8			1
1		1	1	가 ,		3
2		1	2	,		2
3		1	3	「 」 , .		1
4		1	4	가 , ,		2
5		1	4			1



				<	>
6		1	4	(operator) 가	2
7		1	4	「 」	10
8		1	10	.	32
9		2	6	, , . , . ,	8
1		1	4		1
2		1	3	24	12
3		1	3		504
4		1	1		402
5		1	4	30	24
6		1	2		24

					<	>
7		1	1			22
8		1	4			11
9		1	4	Ruby		45
10		1	4			100
11		1	4			6
12		1	4			2
13		1	4	SI		42
14		1	4			26
15		1	4	(治驗)	가	2
16		1	4	. .		12
17		1	8	)	( ,	200
18	( )	1	6		가	1
19	( )	2	4	( )		1

					<	>
20	( )	2	4	( )		1
21	( )	2	8			3
22	( )	2	8			7
23	( )	2	4			3
24	( )	2	6			1
						1,521

1. 1: , 2:
  2. 1: , 2: , 3: , 4: , 5: , 6: , 7: , 8: , 9: , 10:
- : (d)(2009: 36-38)( : 厚生労働省, 「ふるさと雇用再生特別交付金及び緊急雇用創出事業について」, 2009. 4.)

#### 4) 離職者 재취업을 위한 특별교부세 지원 조치

( , )  
가 ,

50%

80%

#### 4. 독일 및 영국 사례

가.

##### 1) 취업지원 기본체계 및 역할

가

. 가 . 가

2 [

]

, ,

. 2005 1 1 2 [

] , 가

가

(BA) 가

( , ARGE) . 350

가 ,

가(認可) 가 .

. 가 69 .

## 2) 연방과 베를린市州의 재정부담

연도	연방 (연방)	베를린市州 (市州)	EU	기타
2008	8,231.5	341.6	751	
가	8.9%			12
2007	15.5%			가
2009	9.8%	2	2	2
가	31.3	9.3%		
2009	56.5	2	2	2
가	7.7%	16.5%	2	2
2009	24.2	80%가	2	2
가				2
< 2-10 >		2		2
2008				16
				6
		13.78		
9.84		3.94		
12				3
87.4%	가	12.6%	가	
				가

< 2-10> 「 」

(2008 , : €, %)

		(2008 )	市州 ( )	聯邦 ( )
	가 , ' ,	€16	-	€ 16 (100%)
		€13.78	€ 9.84 (71.5%)	€ 3.94 (28.5%)
	, ' ,			(100%)
	.	€6		€ 6 (100%)
	, ' ,		(100%)	
12	12	€3	€ 0.378 (12.6%)	€ 2.622 (87.4%)
		€38.78	€ 10.218 (26.3%)	€ 28.562 (73.7%)

2 「 」

. 2

, , 45%

. 5,000

. , ,

, 가

가 .

(

) 1,500 .  
 2,200 .  
 3,800 .  
 가 55%, 45%  
 가  
 1.25 가  
 0.6875  
 0.5625 .

< 2-11> 市州 歐州

		€ 5,000
		€ 1,500
		€ 3,800
		€ 2,200
		€ 1 2,500
歐州	(45%)	€ 5,625
州	(55%)	€ 6,875

: 45% . 2008

가  
 28.6 74% 가 28.6 26%  
 .  
 가 .  
 ,  
 , 가

2008 12 2009 2008 12

가 13 가가

17.5% 15%

2009 1 2 100 ( 23 ) ,

10

30,000

(high-speed broadband)

3 1 ( 2,300 )

(Job-centre Plus)

(Local

Employment Partnership) ‘ National Employment

Partnership)

, ‘ (Job Centre)’



### 5. 각국의 특징 및 시사점

가

1990 SOC

10

206

가

(

가 가 , , , 1990 , . 가 , . , . , . 가 . , . .

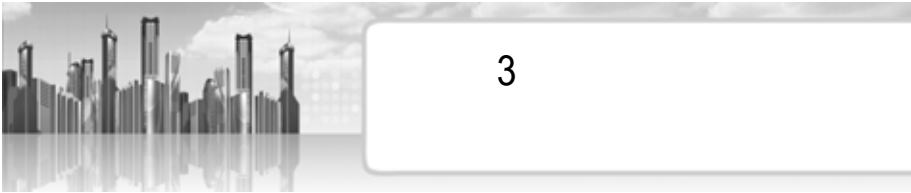

1

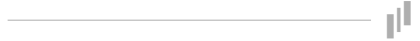

### 1. 일자리의 창출정책의 전개과정

1980

· , ·

, ·

1990

, 가

가

. 1997

2 ~7

<

>

·

2000

가 가

가

. 1998~2002

< 3-1>

1961-1972 (3 )	가 3% , (8%	( '61 ) :
1972-1979 (4 )	가	가 ( '73 ), ( '77 )
1980-1986 (5 )	240 가 , 80 , 86 3	. 1 : ,
1987-1997 (6 , )	2.4%(3 ): 「 가 , , ,	( '95 ) : ( '86 ), ( '90 ), ( 91 ), ( '93 ), ( '97 )
1998-2002 ( )	( '97 ) ,	: 1 ( '98 ) : 156( '02 )

: (2007 : 99)

## 2. 참여정부 이후의 정책 변화

가

.

· , , , .

( , ,

2007:100-102).

2003.10 ,

, , ,

, 6 .

IT , 10 30~40 ,

, ,

가 .

2004 가 . .

‘ , ‘ 가 ,

< > .

,

3가 , 가

, .

,

200 2006 11 ‘

- - , 가 .

< 3-1>



: (2007 : 102)

3가 2003  
 3.5% 2007 46.6% 가 ,  
 2003 2.7% 2007 33.1% 가 .

< 3-2>

( : , %)

	2003	2004	2005	2006	2007
-	3,909(48.5)	6,057(53.3)	6,054(50.9)	7,573(38.4)	8,436(30.4)
-	278( 3.5)	853( 7.3)	1,513(11.8)	6,781(34.4)	12,944(46.6)
-	3,862(48.0)	4,051(39.6)	4,801(37.6)	5,371(27.2)	6,396(23.0)
	8,044(100)	11,365(100)	12,775(100)	19,725(100)	27,776(100)

: (2006:25 2007:103)

< 3-3>

( : , %)

	2003	2004	2005	2006	2007
-	116,258(44.3)	161,061(44.3)	189,322(46.6)	183,614(30.4)	182,307(30.0)
-	7,062(2.7)	27,491(7.6)	41,235(10.2)	111,897(21.0)	201,059(33.1)
-	139,073(53.0)	180,044(49.5)	181,598(44.7)	236,564(44.5)	224,796(37.0)
	262,420(100)	363,596(100)	406,204(100)	531,975(100)	608,621(100)

: (2006:25 2007:103)

가

2007

64.1%

&lt; 3-4&gt;

( )

( : %)

		2005	2006	2007
		2.6	4.6	3.8
		21.4	19.6	17.9
	,	9.6	5.4	4.0
		31.0	25.0	21.9
		2.6	10.8	7.0
		0.7	2.1	1.2
		3.3	12.9	8.2
		28.1	21.2	16.4
		33.2	34.7	47.7
		61.3	56.0	64.1
		1.8	1.5	1.9
		100	100	100

: (2007:105)

가

가

< 3-5> ( )

( : %)

		2005	2006	2007
		5.3	6.7	7.1
		1.5	0.9	0.7
		1.7	1.7	1.3
	( )	0.4	0.5	0.4
		10.2	11.1	7.0
		0.1	0.1	0.1
		19.2	21.0	16.6
		1.3	2.6	2.8
	( 가 , )	0.3	0.2	0.4
		1.8	1.5	1.6
		17.0	16.2	14.3
		0.0	0.0	0.6
		11.9	12.9	13.7
		32.4	33.4	33.3
	( )	0.2	0.1	0.1
		8.7	6.4	5.8
		25.8	25.2	24.7
		12.3	10.2	16.4
		47.0	42.0	47.0
		1.4	3.6	3.1
		100	100	100

: (2007:107)

가 35.9% 26.9% 가  
 14.3%, 8.9% 4 가 86%



&lt; 3-6&gt;

( : , %)

	2006		2007	
	( )	(%)	( )	(%)
	8,073.1	40.1	9,744.5	35.9
	4,281	21.3	7,298	26.9
	237.5	1.2	234	0.9
	3,304	16.4	3,882.3	14.3
	409.9	2.0	1,328.2	4.9
	1,616	8.0	2,423	8.9
	76	0.4	122	0.4
	368	1.8	545	2.0
	93	0.5	146	0.5
	160	0.8	160	0.6
	447	2.2	292.5	1.1
	9.5	0.0	29.2	0.1
	743	3.7	593	2.2
	291	1.4	285	1.1
	0.6	0.0	45	0.2
	2,0109.6	100	2,724.7	100

: (2007 : 108)



	<	>
·		·
·		·
·		·
·		·
·		·
·		·
·		· 가

: (2006 : 20-23)

2



### 1. 녹색뉴딜 사업(09년-12년)

가 ‘ , ’

· ‘ , ’

· ‘ ( )

2009~2018 1,500

, 500 ‘ , ’

2008~2020 100 , 10

· 2007~ 2020

4,000 , 50

‘ , ’ 11 · 36 (9 27

) , 2009 4 3,626 9.3

· 2009~2012 50 96

·

9 가 ,  
 (1 8,349 ), 4 (4,881 ),  
 (3,209 ) 27 (5,137  
 ), (1,782 ), (786 ),  
 (546 )

< 3-8> 2009~2012 ( )  
 ( : , )

	2009	2010~2012		2009	2010~2012	
【 】(9 )	32,223	361,567	393,790	6.3	63.0	69.3
	18,349	781,87	96,536	2.5	11.3	13.8
4	4,881	139,895	144,776	0.7	19.3	20.0
·	3,209	17,318	20,527	0.2	1.3	1.4
	5,784	126,167	131,951	2.9	31.1	34.1
【 】(27 )	11,403	95,299	106,702	3.0	23.3	26.3
	5,137	19,901	25,038	0.9	3.3	4.2
	1,782	3,396	5,178	0.3	0.6	0.9
·	786	6,541	7,327	0.8	4.4	5.3
	546	2,262	2,808	0.1	0.4	0.5
	3,152	63,199	66,351	0.9	14.6	15.4
	43,626	456,866	500,492	9.3	86.3	95.6

: (11 ), 「 New Deal ’  
 , 2009.1.6」

2009 2012

< 3-9>

( : )

					(15~29 )				
4	199,960	199,960	-	-	19,396	19,396	-	-	
	138,067	138,067	-	-	13,392	13,392	-	-	
가	3,120	-	3,120	-	752	-	752	-	
,	16,132	16,132	-	-	1,565	1,565	-	-	
	14,348	12,448	1,900	-	1,665	1,207	458	-	
	16,196	14,933	131	1,132	1,821	1,449	32	341	
가	170,702	170,702	-	-	16,558	16,558	-	-	
,	133,630	133,630	-	-	12,962	12,962	-	-	
eco river	10,789	6,640	1,179	2,970	1,822	644	284	894	
	41,567	41,567	-	-	4,032	4,032	-	-	
	14,546	14,546	-	-	1,411	1,411	-	-	
	19,900	19,900	-	-	1,930	1,930	-	-	
	8,598	8,598	-	-	834	834	-	-	
	2,208	2,208	-	-	214	214	-	-	
	8,268	8,268	-	-	802	802	-	-	
( )	4,980	4,980	-	-	483	483	-	-	
	760	-	760	-	183	-	183	-	
	8,430	6,380	2,050	-	1,113	619	494	-	
	7,767	-	7,767	-	1,872	-	1,872	-	
	1,452	1,280	172	-	166	124	41	-	
	7,400	-	7,400	-	1,783	-	1,783	-	
	6,001	6,001	-	-	582	582	-	-	
	196	-	196	-	47	-	47	-	
	60	50	10	-	7	5	2	-	
(E5)	575	215	-	360	78	21	-	58	
	24,372	24,372	-	-	2,364	2,364	-	-	
가	4,924	4,732	192	-	505	459	46	-	
	9,230	9,010	220	-	927	874	53	-	
,	52,648	49,197	3,451	-	5,604	4,772	832	-	

< >

					(15~29 )			
	3,130	3,130	-	-	304	304	-	-
	850	850	-	-	82	82	-	-
LED	10,030	10,030	-	-	973	973	-	-
IT	10,000	5,300	4,700	-	1,647	514	1,133	-
	1,332	-	1,332	-	321	-	321	-
	2,800	2,800	-	-	272	272	-	-
	920	230	690	-	189	22	166	-
	532	-	-	532	160	-	-	160
	956,420	916,156	35,270	4,994	98,820	88,867	8,500	1,453

: (1) ·SOC :2005 . (2)  
R&D . (3) 가 .  
(4) .  
:

, 2009 2012

< 3-10> 2009~2012

( : )

					(15~29 )					
		09	10	11	12	09	10	11	12	
4	199,960	7,200	87,320	87,320	18,120	19,396	698	8,470	8,470	1,758
가	138,067	25,042	32,549	37,176	43,300	13,392	2,429	3,157	3,606	4,200
	3,120	816	768	768	768	752	197	185	185	185
,	16,132	4,082	4,654	4,917	2,479	1,565	396	451	477	240
	14,348	1,643	2,908	4,712	5,085	1,665	374	400	428	464
	16,196	2,377	5,182	5,380	3,257	1,821	317	582	591	331

&lt; &gt;

		(15~29 )										
		09	10	11	12	09	10	11	12			
가	170,702	29,898	40,294	46,883	53,627	16,558	2,900	3,909	4,548	5,202		
,	133,630	13,280	20,750	42,330	57,270	12,962	1,288	2,013	4,106	5,555		
eco river	10,789	2,383	2,713	3,043	2,650	1,822	480	480	479	385		
	41,567	8,529	10,234	12,281	10,523	4,032	827	993	1,191	1,021		
	14,546	3,236	3,480	3,770	4,060	1,411	314	338	366	394		
	19,900	3,671	4,517	5,350	6,362	1,930	356	438	519	617		
	8,598	2,959	2,045	2,227	1,367	834	287	198	216	133		
	2,208	253	888	591	476	214	25	86	57	46		
	8,268	2,067	2,067	2,067	2,067	802	200	200	201	200		
( )	4,980	830	830	1,660	1,660	483	81	81	161	161		
	760	350	150	130	130	183	84	36	31	32		
	8,430	3,620	3,660	540	610	1,113	413	423	130	147		
	7,767	1,200	1,740	2,433	2,394	1,872	289	419	586	578		
	1,452	171	299	427	555	166	26	36	47	57		
	7,400	1,700	1,700	1,900	2,100	1,783	410	410	458	505		
	6,001	431	1,685	2,123	1,762	582	42	163	206	171		
	196	42	47	52	55	47	10	11	13	13		
	60	-	10	-	50	7	-	1	-	6		
(E5)	575	60	15	100	400	78	8	2	13	55		
	24,372	7,876	4,470	5,490	6,536	2,364	764	434	533	634		
, 가	4,924	582	1,022	1,308	2,012	505	66	107	133	199		
	9,230	635	2,865	2,865	2,865	927	68	286	286	287		
'	52,648	12,489	13,057	13,388	13,714	5,604	1,353	1,401	1,401	1,449		

	< >									
						(15~29 )				
		09	10	11	12		09	10	11	12
	3,130	580	660	820	1,070	304	56	64	80	104
	850	95	196	269	290	82	9	19	26	28
LED	10,030	240	2,730	3,260	3,800	973	23	265	316	369
IT	10,000	3,000	3,000	2,000	2,000	1,647	437	437	386	387
	1,332	333	333	333	333	321	80	80	80	81
'	2,800	50	625	1,125	1,000	272	5	61	109	97
	920	20	300	300	300	189	3	62	62	62
	532	133	133	133	133	160	40	40	40	40
	956,420	141,873	259,896	299,471	255,180	98,820	15,366	26,750	30,541	26,162

:

## 2. 재정을 통한 긴급고용 대책 : 2009년 일자리 예산 중심으로

2009 4 5,489 19  
 ' ' 32 (2.7 )  
 , 430 (1.8 )



< 3-11> 2009

( : , , %)

	( )	( )	
【           】			
	12,366 (27.2)	126 (2.7)	18% 가
	12,309 (27.1)	30 (0.6)	
	2,557 (5.6)	165 (3.6)	(575 , ) (1,166 )22% 가
	27,231 (59.9)	321 (6.9)	
【           】			
	16,087 (35.4)	4,259 (92.1)	
	1,155 (2.5)	13 (0.3)	103% 가
	873 (1.9)	15 (0.3)	94% 가
	143 (0.3)	15 (0.3)	
	18,258 (40.1)	4,302 (93.1)	
	45,489 (100.0)	4,622 (100.0)	

:

:

(c)(2009 : 2)

2009.3

17.7

3.5

< 3-2>

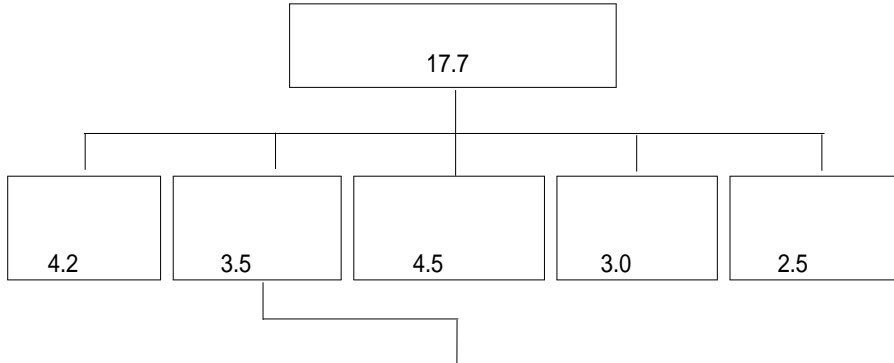

	( )	( / )	
( )	28,159	55	,
-	644	1.2	
- ( )	19,950	40	
-	2,879	3.3	
- , , ( )	801	3.2	
-	277	3.6	
-	1,621	33	,
-	203	9.4	
-	93	0.5	
- ( )	100	10	
-	213	0.8	
- .	5,119	22	
-	3,070	14.3	
- ( )	992	6.1	
- ( )	182	1.7	
-	111	0.6	

: (b)(2009 : 33)

,

5

,

.

< 3-12> 「 」

( ) : 2 8,159 (55.2 )				
			: 3.3 (12.9 16.1 )	: 2,897 , (1 2,366 1 5,245 )
가	,	120	2.1 2.8	: 1,081 (3,132 4,212 )
( )	가	1 100 ( ), 8	0.6	: 375 70%
( )	1	73 + 8.5%(6 )	15 25	445 (1,885 2,330 )
( )	120%	83 , 6 (50%), (50%)	40 가 (86 )	2 (78%) 0.6 2.6
		110 , 8	0.6 1	: 183 (190 374 ) 30% 50%
	65	20 , 7	16 19.6	: 277 (1,155 1,432 )
		120 , 18 가	2.5	: 478
: 1,621 (32.8 )				
		3 50%	4 100 (7.5 )	: 150
	,	36.2 , 5 , 6	8 16	: 213 (985 1,199 )
· : 5,119 (22.8 )				
	,	· 2/3~3/4	6.5 20.8	: 3,070 (583 3,653 )

< >

		1/2( 1/3), 1 (2009. 5 )	620	30
	3 4,899	(110.8 )		
	2009. 3	:	19.5	
	· 95	(2009. 3 ),		47.8 (2009.2 )
	· 2009. 3		(19.5 )	76.4%(15 )가 ,
	20-30			가
	- 20	8.9 , 30		14.1

: (b)(2009 : 34)

, 2,573 .

< 3-13> 「 」

	( )	: 2,061 (5.6 )		
		110 , 8	0.6 1	: 183 (190 374 ) 30% 50%
		110 , 6	0.7	: 323 70%
	가	1 100 ( ),	0.6	: 375 70%
( )		8		
		50%, ( 50-80 ),	2.5 3.7	: 644 (985 1,629 )
		6		
( )		120 ( )	700 1,000	: 58 (204 262 )
		가		

< >				
		120 ( 18 )	2.5	: 478
: 401 (8.7 )				
		3 50%	4 100 (7.5 )	: 150
		: 2,700 , : 3,600	674 1,006 : 175 : 157	: 104 (202 306 )
	NEET	30 ( , )	1 1.5	: 93 (84 176 )
		40	0.7 1.4	: 54 (151 205 )
· : 111 (0.6 )				
		30 , 1	0.6	: 111
2,573 (14.9 )				
	2009. 3	39.4%,	8.8%	
	·	57.9%,	4.0%	
	·		118 (2009. 2 )	
	· 2009. 2	46 ,		
	· 2009. 3		(19.5 ) , 20	45.6%(8.9 )

: (b)(2009 : 35)

### 3. 희망근로 프로젝트

2009

2009 1 3,280 , 3,790 1 7,070  
가 25 (6  
)

(4 가 133 ) 120% , 1 3,500  
 . 6 83 ,

가 (bottom-up)  
 (3-4 ) 가 (5 ) 가  
 가 (6 -11 ) .  
 < 3-14> .

< 3-14>

	1 3,280 , 3,790 1 7,070 ( 1 2,450 (75%), 4,680 (25%) ( 77.80%, 11.19%, 11.01%)
	(4 가 133 ) 120% , 1 3,500 25
	가 (6 )
	83 ~86 50%, 50%
	28 ( )

. 4 , (16 ) ,  
 (16 ) , (1 ) (8 126 )  
 . 4 ,

, , ,  
 , , , , 16 1  
 , , . 1  
 8 126  
 . 가  
 .

< 3-15>

4 (4 )	- " "
(16 )	- DB - , - , - , - , - , - , -

		<	>
(16 )	- Green Trekking Circle( )		
	- Green Way ( )		
	-	( )	
	-	( )	
	-	( )	
	- Green Way ( )		
	-	( )	
	-	( )	
	- 가 ( )		
	-	( )	( )
	-	( )	
	- , 가 ( )	( )	
- Career ( )			
(1 )	-		
	- 8 , 126		
	<input type="checkbox"/>	<input type="checkbox"/>	
	<input type="checkbox"/>	<input type="checkbox"/>	
	<input type="checkbox"/>	<input type="checkbox"/>	
	<input type="checkbox"/>	<input type="checkbox"/>	

**4. 녹색일자리 창출사업**

· , 가  
· , 가  
·  
( ) 5 (2009-2013) 가  
가 (1.3%) (6.0%) 가 2013



81 ('08 20 가) 3)  
 (2007)  
 , 61 (2008 ) 24  
 , 54 , 251 ,  
 102 , 179 '09 ~'13  
 6.0% 가 '13 81 가 ( 가 1.3%) . 2013 30 ( 가 4.4%), 72 (5.9%), 278 (2.1%), 127 (4.6%), 307 (11.4%)

< 3-16>

		, 가 , 가
LED	LED	LED ,
IT		(IT)
		가 (液狀)

3) 5 '09~'13 118~147 ( 23~29 ) , ( ) 2 ( . )

		< >
·	(U-City) 가	IT , U-City IT U-City U-City
	가	가 , ,
	가	(pattern), , ,
·	* 가	GPS 가 GIS, , ,
		가· , 가
		·
		· , B/C

: ,“

” 2009 9 4

### 5. 사회적 일자리 사업

가.

’ ’ ’ ’  
 .  
 “ 가 가 ”  
 ,  
 . 가  
 ,  
 .  
 2003 8 .  
 “  
 , ”  
 ”  
 .  
 가 ‘  
 , .  
 IMF  
 .  
 , , .  
 . :  
 ,  
 가 ,  
 .

1998 「 」 .  
 , , , , .  
 , .  
 2004 7 4 2,501 ( 2 5,101 ,  
 1 7,400 ) 360  
 . 2005 ,  
 , , 가  
 2009 6 ~ 11 6 .  
 , , .  
 , .  
 (3,790 ) (13,280 )  
 가 .  
 , 가  
 가 .  
 . :  
 , 「  
 」 1999 2000 「  
 . 「 」  
 ,  
 (workfare)

가 .

( ) . 2003  
,

, , , , 5

가

,

· :

,

·

,

·

· , 가

,

, ,

·

·

가 2003 8 .  
 2004 . 2004 2008  
 , 2003

< 3-17> ( )

	2003	2004	2005	2006	2007	2008
		6	7	8	11	10
( )	73( )	949	1,691	6,782	12,945	15,729
( )	2,000	47,491	69,314	111,897	201,059	228,154

: (www.socialenterprise.or.kr)

“ ”  
 , , , , 5 .

< 3-18> , , , , ( )

	· , , , ,
	· ,
	· , , , , , 가
	· , ( ), ,
	· , . ,

: (2003), 2003

“ ”  
 , , 가

, .  
 , , 가  
 . 2008  
 ‘ , .  
 :  
 , . 2007  
 「 , 2008 「  
 (2008-2012)」  
 . , , , ,  
 ‘ , , , ,  
 2012 1,000  
 .  
 (2008) , “  
 .  
 ” , “ 가 , ,  
 , ,  
 ” .  
 ,  
 .  
 가  
 , 3 ,

가  
 ( , 2008) 46  
 ,  
 가 “ (40%)”  
 . 가가 “2012 1,000  
 ”  
 가 .

**6. 지방자치단체의 일자리창출 사업 : 경상남도 사례**

2009 , , . 78 7  
 .  
 가 , ,  
 ,  
 ,  
 ,  
 ,  
 가 ‘ (worknet)’ .



&lt; 3-19&gt;

(2009 )

	( )					
(78 )	251,892 (100%)	120,344 (47.78%)	49,452 (19.63%)	82,096 (32.59%)	70,344	
(22 )	28,431	11,231	9,408	7,792	11,785	
(14 )	12,981	5,007	2,987	4,987	2,959	
1. EG	520	-	520	-	400	
2.	200	-	200	-	40	
3. IT	192	-	192	-	40	
4.	4,819	1,205	661	2,953	438	
5.	600	-	300	300	200	
6.	500	500	-	-	100	
7.	1,000	450	550	-	100	
8.	2,595	1,298	31	1,266	124	
9.	635	318	-	317	38	
10.	108	-	108	-	15	
11.	413	173	89	151	27	
12.	559	559	-	-	36	
13.	840	504	336	-	28	
14. ( , , )	-	-	-	-	1,373	
(4 )	4,710	2,754	1,756	200	1,645	
15.	276	-	276	-	920	
16.	2,790	2,000	590	200	50	
17.	320	-	320	-	200	
18. ( , )	1,324	754	570	-	475	
(4 )	10,740	3,470	4,665	2,605	7,181	
19.	4,325	360	3,965	0	7,000	
20.	-	-	-	0	100	
21.	3,041	1,960	400	681	38	
22.	3,374	1,150	300	1,924	43	
	222,176	108,623	39,354	74,199	38,609	
(38 )	172,468	100,621	28,416	43,431	25,747	
23.	906	300	170	436	140	

&lt; &gt;

	( )					
24.	560	392	84	84	83	
25.	232	116	58	58	80	
26.	644	322	322	-	46	
27.	640	320	168	152	42	
28.	2,170	1,085	543	542	150	
29.	1,108	462	462	184	132	
30. 가	7,232	5,376	928	928	934	
31.	4,445	3,301	572	572	542	
32.	2,287	1,676	306	305	162	
33.	10,144	7,101	1,014	2,029	600	
34.	3,294	2,306	494	494	120	
35.	20,995	14,928	2,927	3,140	3,030	
36. ,	1,962	1,570	196	196	1,721	
37.	1,677	838	-	839	53	
38.	713	570	143	-	28	
39.	3,886	1,943	12	1,931	186	
40.	3,771	1,885	943	943	168	
41.	426	170	128	128	22	
42.	54,944	27,472	10,989	16,483	3,431	
43.	1,963	1,375	294	294	250	
44. 가	221	155	66	-	70	
45.	790	-	79	711	65	
46. 가	218	130	38	50	16	
47.	4,232	2,140	701	1,391	2,203	
48.	558	335	67	156	40	
49.	4,984	2,990	609	1,385	392	
50. 가	16,359	9,965	1,918	4,476	1,062	
51.	150	90	18	42	11	
52.	163	98	27	38	12	
53.	204	122	82	-	15	

		( )				<	>
54.	가	1,113	-	167	946	530	
55.		455	227	68	160	35	
56.		60	30	9	21	5	
57.		81	48	10	23	8	
58.		816	-	163	653	34	
59.	(4 )	14,565	7,283	3,641	3,641	8,861	
60.		3,500	3,500	-	-	468	
	(11 )	49,708	8,002	10,938	30,768	12,862	
61.	IT	50	-	50	-	20	
62.		20,006	1,805	812	17,389	3,057	
63.		3,836	728	1,078	2,030	600	
64.		180	-	90	90	60	
65.	( , , )	750	-	750	-	800	
66.		154	77	34	43	48	
67.		350	100	75	175	30	
68.		279	-	-	279	20	
69.		162	113	49	-	27	
70.		21,973	3,801	8,000	10,172	8,000	
71.		1,968	1,378	-	590	200	
	(7 )	1,285	490	690	105	19,950	
72.	( , )	150	-	90	60	1,000	
73.		20	-	20	-	300	
74.		180	90	45	45	2,000	
75.		35	-	35	-	50	
76.		900	400	500	-	600	
77.	(21 )	-	-	-	-	11,000	
78.	SOC (118 5600 )	-	-	-	-	5,000	,
	(2 )	4,500	4,500		-	1,258	
		1,500	1,500		-	258	
	( )	3,000	3,000		-	1,000	

:

### 3 가

#### 1. 일자리창출 관련 정책의 평가

가. :  
 ( , 2009:22)  
 1 가 , , 가 , ,  
 ( , 2009:20).  
 , GDP , ,  
 < 3-20> 가

( :%p)

	GDP		가		
	0.023	-0.002	0.003	0.051	0.003
	0.039	-0.003	0.005	0.018	0.128
	0.013	-0.001	0.001	0.007	0.003

: (a)(2009 : 22)

1

, , 가 , ,  
 ( (a), 2009:24-30).

가

, ' . '

가 . 가 , ,  
 ‘ . ’ 가 가 .  
 ‘ ’ 가 가  
 . ‘ ’ 가  
 ‘ ,  
 .

< 3-21>

( :%p)

	GDP		가		
1.	0.0223	-0.00145	0.00301	0.04500	0.00464
2.	0.0163	-0.00107	<b>0.00187</b>	0.00968	0.01446
3. .	0.0190	-0.00124	0.00244	0.03035	0.00473
4.	0.0229	-0.00152	0.00274	0.01415	0.04423
5.	0.0229	-0.00149	0.00312	<b>0.04787</b>	0.00455
6.	0.0230	-0.00151	0.00300	0.03601	0.01937
7.	0.0232	-0.00151	0.00312	0.04482	0.00970
8.	0.0229	-0.00149	0.00312	<b>0.04843</b>	0.00374
9.	0.0226	-0.00147	0.00307	0.04648	0.00481
10.	0.0248	-0.00162	0.00326	0.03946	0.02456
11. .	<b>0.0275</b>	<b>-0.00181</b>	0.00359	0.03871	0.04017
12.	<b>0.0302</b>	<b>-0.00200</b>	0.00387	0.03410	<b>0.05982</b>
13.	0.0173	-0.00114	<b>0.00207</b>	0.01639	0.01202
14.	<b>0.0304</b>	<b>-0.00202</b>	0.00387	0.03082	<b>0.06494</b>
15.	0.0228	-0.00148	0.00310	0.04744	0.00449

: (a)(2009 : 25)

가 GDP 가 ‘  
 , ‘ , ‘ . ‘ 가



,  
 . 가 가 .  
 가 가  
 가 .  
 ,  
 . 3  
 가 30 가  
 ,  
 , , ,  
 .  
 .  
 ,  
 . 가  
 가 .  
 .  
 .  
 ,  
 . 가  
 .

· :  
 (2007) ,  
 · , ,  
 가 ·  
 ,  
 가  
 · ( ) ,  
 ( ) , ( ) 가  
 , ,  
 · , 가 · 가  
 · ,  
 3 ,  
 8 ,  
 8  
 4 ·  
 가  
 · 가  
 14 ·  
 가



&lt; 3-22&gt; 16

(2000~2006)

	( )	( )	( )	
	10	12	5	9
	13	15	11	14
	9	10	8	9
	5	5	12	7
	4	4	2	3
	2	2	3	2
	3	6	14	8
	1	1	1	1
	12	11	13	12
	11	8	15	11
	8	3	6	4
	15	14	16	16
	16	16	10	15
	14	13	9	12
	7	7	7	6
	6	9	4	5

: (2007: 85)

, 가

( , 2007:91).

, 가

· , ,

, , ) ( ,

,

“ ” .

3 가 .  
 가 ( ) ,  
 . : ,  
 (2009) ,  
 가 .

< 3-23 >

		(2008 , 2009 )			
		2008		2009	
		( )	( )	( )	( )
		13,863	64,869	17,113	91,147
		829	3,172	1,200	9,399
		50	510	52	688
		2	26	2	27
		6	78	13	178
		884	3,786	1,267	10,272
		282	445	412	625
		155	1,707	142	1,755
		10	176	10	193
		98	1,790	118	1,607
	가	298	1,554	300	3,486
		800	5,470	592	4,266
		9	68	20	143
		3,000	14,202	3,000	16,208

		2008		2009	
		( )	( )	( )	( )
		4,652	25,412	4,594	28,283
		0	0	100	984
		6,909	12,112	8,838	15,709
		6,909	12,112	8,938	16,693
	( )	0	0	280	247
	가	120	416	300	1,317
		7	62	8	129
		127	478	588	1,693
		113	1,976	119	2,642
	( )	17	325	17	432
		61	1,847	61	1,988
	, 가 ( )	0	0	195	2,114
		20	292	22	304
		60	9,582	118	2,632
		271	14,022	532	10,112
		110	1,252	120	1,336
		838	5,896	980	8,776
		948	7,148	1,100	10,112
		17	686	17	1,209
		25	380	25	360
		22	738	36	12,093
		5	107	16	320
		69	1,911	94	13,982

: (2009 : 28-30)

2009 ,  
14.2%

< 3-24>

(2008 , 2009 , )

		2008		2009	
		( )	( )	( )	( )
		9,821	7,080	15,594	12,953
		410	726	235	370
		37	60	40	80
	· ·	5,880	95	10,000	1,823
	Biz-Academy	112	320	205	345
		0	0	-	100
		110	200	190	342
		1,927	4,618	3,100	7,900
	Win-Start	0	0	300	200
	( )	936	16	1,000	22
		20	65	20	55
	·	8	122	14	231
		4	190	10	780
		167	11	240	13
		0	0	30	64
		60	60	60	30
	가	150	597	150	598

: (2009 : 32)

2009

가 ,

1 100 ( 100%)

2008 39 2009 59 51.3% 가 ,  
 7,426 2008 2,831 162.3% 가 .

&lt; 3-25&gt;

	2008			2009		
		( )	( )		( )	( )
	2	75	62	3	275	1,580
	3	30	197	4	28	201
	0	0	0	2	80	492
	0	0	0	1	108	392
	10	376	458	18	682	936
	3	230	203	4	280	594
	2	380	197	3	42	302
	16	258	542	20	460	1,194
	0	0	0	1	183	254
	3	458	1,172	3	757	1,481
	39	1,807	2,831	59	2,895	7,426

: (2009 : 34)

가

가

가

,

,

가 가 .

.

1 1

6 .

.

**2. 입자리창출 관련 정책의 문제점**

가. . .

가

가

가 ,

가· 가 .

,

가

가

가 ( )

( ) ,

가 , , . , .

< 3-26> :

		<p>( )</p> <ul style="list-style-type: none"> <li>- : (GDP), ,</li> <li>- :</li> </ul> <ul style="list-style-type: none"> <li>- , , . :</li> <li>- , . : 가</li> <li>- :</li> </ul> <p>, 가, 가</p>
		<ul style="list-style-type: none"> <li>- (4+9 )</li> <li>. ,</li> <li>가 ,</li> <li>가</li> </ul> <ul style="list-style-type: none"> <li>- . ,</li> </ul> <ul style="list-style-type: none"> <li>- . ,</li> </ul> <p>가 가</p>

< >

		-
		- , ,
		- ,
		- 가 가
		가 가
		-
		- ,
		-
		- 2008 ' ,
		, , * ,

2008

, , \*

.

,



가 . , , , .

< 3-27> :

	- • ( ) • - • : , GRP , 1 - • : ( , ) , ) - • ( ) - - , 가 ( , )	* *
	- : - : - : - : ( )	* 가
,	- , - - ( )	*
	- 가 -	* *
	-	*



1



‘ ’

1990

1990

가 IMF

2008

,

,

,

,

.



( ) , , 가 가 . , . 가 .

< 4-1>

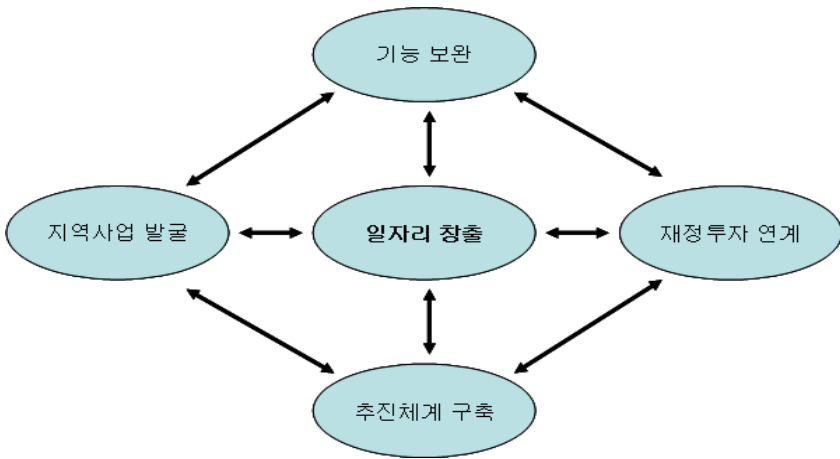

2

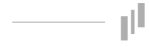

1. 지방자치단체의 입지리창출 기능의 종합화 및 효율성 제고

2009

40

2010

55

, 가

가 .

가

가

가

가

가

가

가 .

가

## 2. 중앙정부 일자리창출 관련 기능의 지방이양

가.

가

가 .

가

가 가

( 1 )

- , , , .
- ( , , )
- . , , , ,  
가

( 2 )

- , , .
- ( , , )
- ( 6 ) , , ,  
,

&lt; 4-1&gt;

가

	1 :	2 :
	-	
	- ,	
	- ,	
	- , ( )	- , ( )

， ， ，  
·

， ， ·

·

·

가

·

( 1 )

-  
-  
-

，

가

，

( 2 )

-  
-  
-

-

，



가

< 4-2>

가

	1 :	2 :
-	· , , · , ( ) ,	
-	, ( )	
-	( )	
-	( · · )	
-		-
-		-

3



### 1. 지역정책의 지역입자리 창출과 연계

가.

가

, ,

· ·

, 가

, ,

( , 2007:112-113).

,

.

.

50%, 25%, 25% 1

200

2006 9

9

.

,

가 , 가  
가 . 가

< 4-3>



< >

		2006	2007	2008	2009	2010( )
		12,620	25,558	36,399	38,980	10,000
		3,000	3,800	11,475	11,825	2,250
		4,870	17,212	21,174	21,155	3,250
	( )	4,750	4,546	3,750	6,000	4,500
		6	6	8	7	3

	<ul style="list-style-type: none"> <li>▪ , ( , ) : 3</li> </ul>	
	<ul style="list-style-type: none"> <li>▪ , 가 : 5</li> </ul>	
	<ul style="list-style-type: none"> <li>▪ , , , : 5</li> </ul>	
	<ul style="list-style-type: none"> <li>▪ , , : 3</li> </ul>	
	<ul style="list-style-type: none"> <li>▪ , , : 3</li> </ul>	
	<ul style="list-style-type: none"> <li>▪ , , : 3</li> </ul>	
	<ul style="list-style-type: none"> <li>▪ ( , ) : 3</li> </ul>	
	<ul style="list-style-type: none"> <li>▪ , 가 : 3</li> </ul>	
	<ul style="list-style-type: none"> <li>▪ 가 , 5R( , , , ) : 3</li> </ul>	

○ 가

○

○ ,

가 ( 가 , 2007:114-115).

가 가 가 .

< 4-2 >

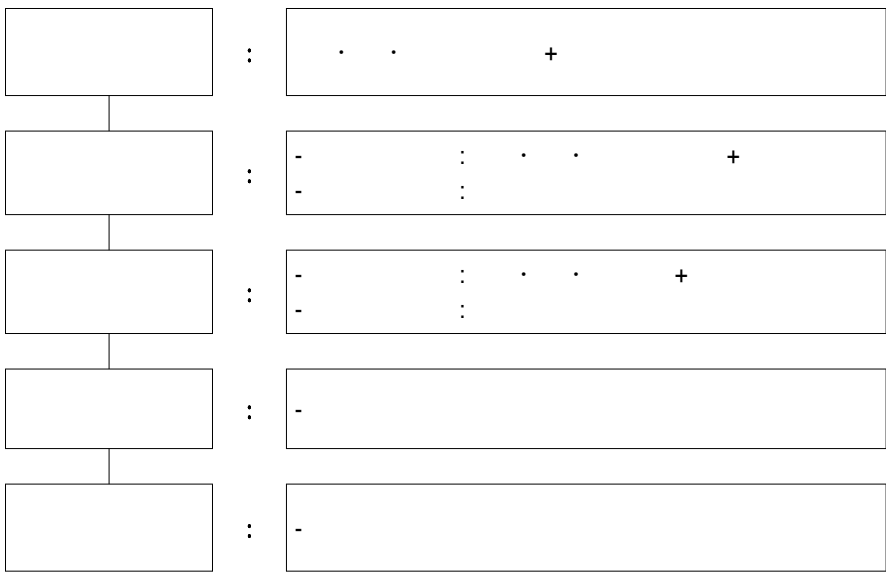

: (2007 : 115)



· ·

( , 2007:114).

·

’ ’ 가 .

’ ’ ’  
·

가 가 .

· ’ ’

’

·

< 4-3 >

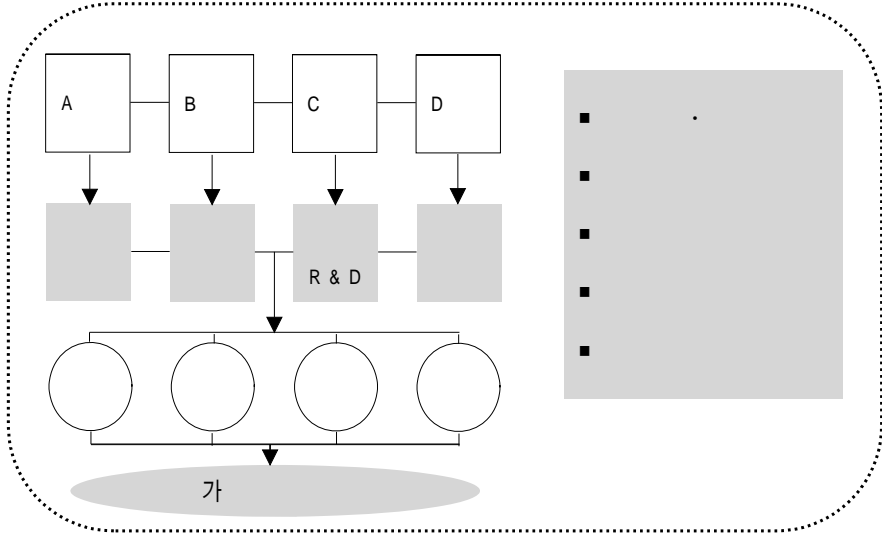
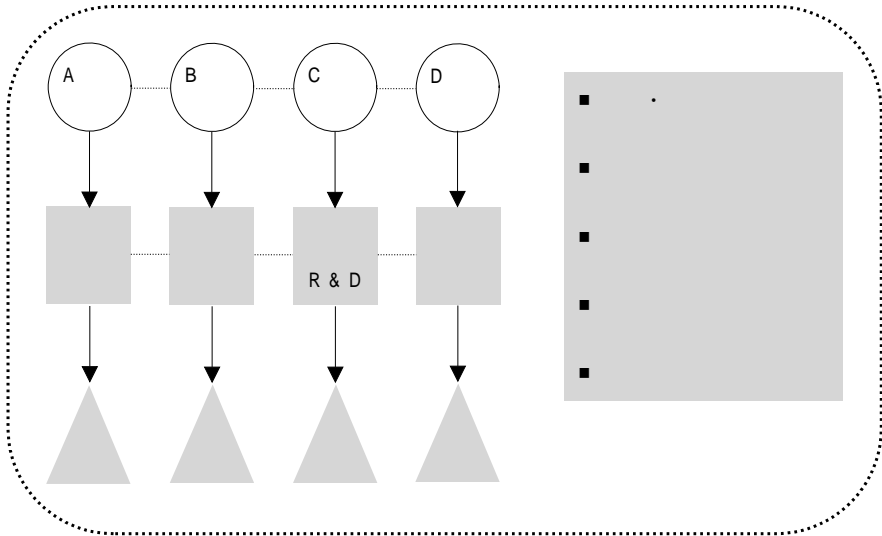

: (2007 : 116)

가

가가

가 . 가 가  
 가 . 가 가  
 가 , 가 ,  
 가 가 .

< 4-4>

가

· · · R&D · ·	· 가 · 가 · R&D 가 · 가	가 가 가	· 가 ·
· · · ·	· ·		· 가 ·
· · ·	· 가 · 가	가 가	· 가
· · · · · · ·	· 가 · 가 · 가 · 가	가 가 가 가	· 가 ·

		< >	
	·	· 가 가 · 가 ·	· 가 ·
	· · · ·	· 가 · 가 · 가 · 가	· 가 ·
	·	·	· 가
	· · · ·	· 가 · 가 · 가	· 가 ·
	· · ·	· 가 · 가 · 가	· 가 ·

: (2007 : 20)

## 2. 지역특성과 연계된 지역일자리 발굴 추진

가 .

. OECD

, ,



< 4-5> OECD

	- :	- :	
	-	-	
	-	-	
( )		-	
		·	
		-	
		·	
		- ( )	
		·	가
	-	-	
	-		

SOC, · , 2012 50  
 96 , ,  
 , , 가가  
 10 700 가가 350  
 , , 30  
 ,  
 2009 1.2 12.5 , ,  
 2009 25 2010  
 , 2013  
 20 .

,

5 1 .4)

가 .

가 .

2009 가 . ,

가 .

가 .

4

가

---

4) 10 8~9% 350 가  
 ( , 2009:2)

가 .

가 .

### 3. 기업지원을 통한 맞춤형 일자리창출 유도<sup>5)</sup>

가 .

가 .

---

5) (2009.6.9) “ ”, SERI , 246  
 가 .



가

‘Buy Local’ 가 .

		‘Buy Local’	
-	Lancaster	300	30
-			
-	10		
-	30% 2 ( 2 7 )		

: (2009.6.9 : 3)

#### 4. 커뮤니티 비즈니스 활성화

(Community

Business)<sup>7)</sup> 가 .<sup>8)</sup>

, NPO,

가  
(CB)가

7)

(2009.10.28)

8) 1980

60

2008 2,400

2011

2 2,000

< 4-4>



: (2009. 10. 28 : 2)

< 4-5> CB



: (2009. 10. 28 : 13)

- (47 29 )가  
 - : (19 ), (15 ), (13  
 ), (12 ), (4 )  
 - : (26 ), (25 ), NPO (9  
 , (7 )

: (2009. 6. 9 : 11)

· , ,  
 ,  
 .  
 , ,  
 가 .  
 ( - ) ( - )  
 6가 가  
 .  
 가 가 .

< 4-6>

가

		가
CB	· . ·	· 空洞化 舊 , · (日) :
C B	· · ,	· · (日):
CB	· , · 先	· / · ReBoot(英) : PC IT
CB	· ·	· ‘地廢地活’ ( ) · ‘ 가 ’( ) :
CB	· 脫 , ·	· , , , · SHCA(英) :
CB	· CB · CB 가 ,	· CB · CB (日) : CB

: (2009.10.28:12)

4



### 1. 입지리창출 성과와 연계한 재정지원



가 가

, , ,

9)

가 가 .

,

가 가

.

---

9) ( , , )

3 가 30

'04 6 '09 227 (281 )

1,886 .

5 3,169 ( 28.2 ), 16,451

( , 2009 6 23 ( ) ).

< 4-7>

	( ) (70% ) *
	(70% )
	20 1 6 60
	20 6 60
	- 가 70% 가가 ( )
	-
	· 70:30( 3 20% 75:25)
	· 90:10( 3 20%)
	95:5)
	* 3 20% :
	60
	*1 , , ,

**2. 입자리창출 포괄보조금 도입**

가

·

· 가

· 가

· 가

· 가

· 가

· 가

· 가

(SSBG:Social Service Block Grant) ( , 2007:62-75). 1982 . 1993

29가

< 4-8>

(SSBG) 가

- (Adoption Services)	- (Foster Care-Child)	- (Protective & Services-Adults)
- (Case Management)	- (Health-related Services)	- (Protective Services-Child)
- (Congregate Meal)	- 가 (Home-based Services)	- 가 (Recreation Services)
- (Counseling Services)	- (Home-delivered Meals)	- (Residential Treatment)
- (Day Care-Adults)	- (Housing Services)	- (Special Services-Disabled)
- (Day Care-Child)	- / (Transitional Living)	- (Special Services-Youth at Risk)
- (Education & Training Services)	- (Information & Referral)	- (Substance Abuse Services)
- (Employment Services)	- (Legal Services)	- (Transportation)
- 가 (Family Planning)	- (Pregnancy & Parenting)	- (Other Services)
- (Foster Care-Adults)	- (Prevention & Intervention)	29

: (2007:70)

가

&lt; 4-9&gt;

(SSBG)

(Self - Sufficiency)	(Protection)	(Maintenance)	
1. 가 (Family Planning)	1. (Child Protection Services)	1. (Homemaker-home Health Services)	1. (Mental Health Case Management)
2. (Child Day Care)	2. (Abuse Prevention)	2. (Home Delivered meals)	2. (Elderly Case Management)
3. (Day Care for Developmental Disabled)	3. (Emergency Shelter)	3. (Day Care Aged)	3. (Welfare Case Management)
4. (Adoption Services)	4. (Adult Day Care)	4. (Congregate Meal)	4. (Transportation Services)
5. (Work Activity)	5. 가 (Foster Care Placement)	5. (Respite Services)	5. (Intensive Crisis intervention)
6. (Halfway House Seriously Mentally )	6. 가 (Adolescent Foster Care)	6. (Hospice)	6. 가 (Home Management)
7. (Residential Treatment Chemical Dependent)	7. (Adult Emergency Shelter)		7. (Day Treatment)
8. 가 (Family Development)	8. 가 (Homemaker)		8. (Initial Clothing)
9. (Halfway House for Alcoholic)	9. (Interstate Child Services)		9. (Maternity Home Care)

		< >	
(Self - Sufficiency)	(Protection)	(Maintenance)	
10. (Special Development)	10. (Residential Treatment)		10. (Repairs or Reconstruction)
	11. 가 (Foster Care)		
	12. (Unmet Medical Needs)		
	13. (Comprehensive Residential Care)		

: (2007:71)

가

가 .

< 4-10>

, 가

가 .

< 4-10>

		( )	
		( . . . )	
		,	
		, . . . ( )	
		. . . ( )	
		가	. . . ( )
			가
			가
			가
		가	가
		가	. . . ( )
		. . .	
		,	
		,	
		. . .	
	5		
		. . .	
		. . .	

			< >
		가	,
			· · ( )
			· · ( )
			,
			가
			· ·
		가,	, · · ( )
			· ·
			, ,
		· · ,	

### 3. 보통교부세 재정수요항목 신설

, . . .

2009

'08 24.9%(13.7 ) '09 30%(17.1 ) .

, 10%-20% ,

.

.

< 4-11>

08	19.3 (35.1%)	22.1 (40.0%)	13.7 (24.9%)
09	17.0 (30.0%)	22.7 (40.0%)	17.1 (30.0%)

< 4-12> 2009

		'08 24.9%	'09 30%
		“ 가 ”	
		10%~20%	

2009

( )

가

가

가



3000  
 , , 3 . 10  
 ,  
 가 .

#### 4. 지방세 감면의 연계

가 .

5 100% 2 50%  
 3 , 2 50%  
 . 2008.9.1 1  
 13%, 1 25% 2008  
 2 2 11% 2% 2 22%  
 3% 2010 2 10%, 2  
 20% .  
 ,  
 .  
 가 .

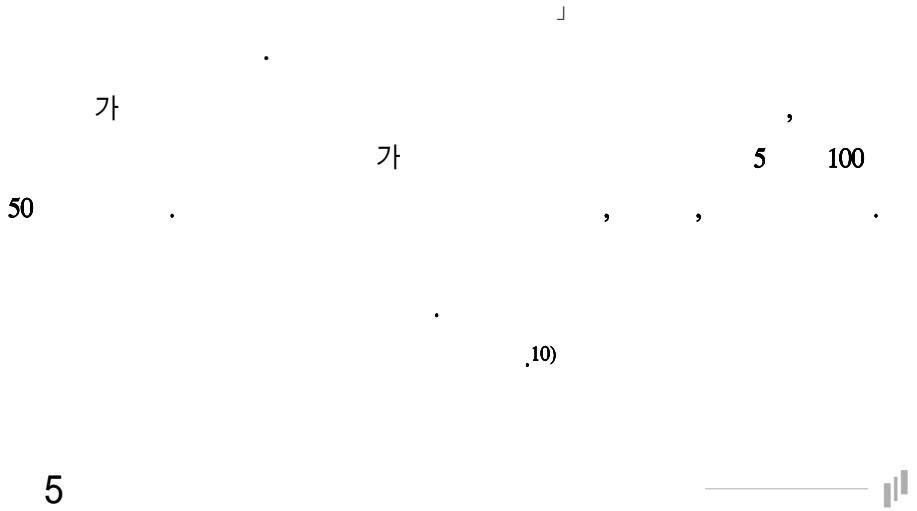

### 1. 입자리창출 추진기구 설치 및 자치단체 자율성 강화

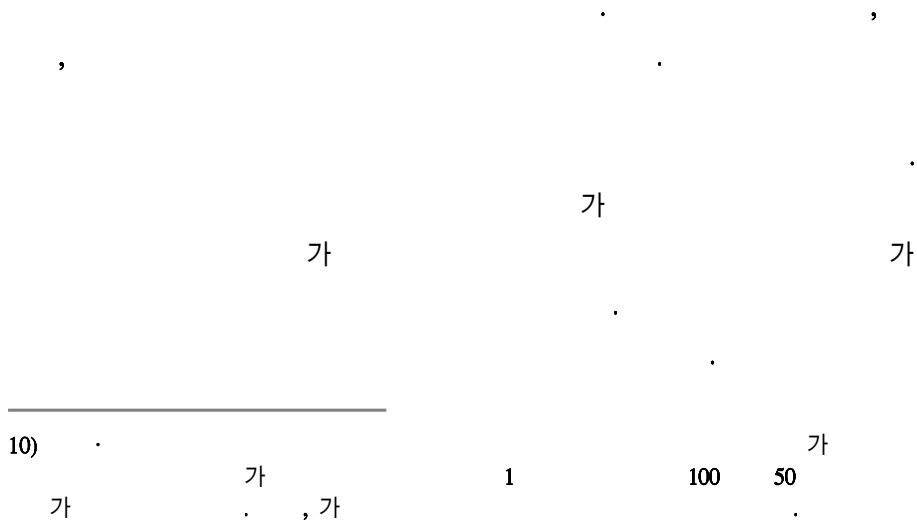

가 .

11

36

가

,

,

,

,

.

가

.

가

.

.

가

.

,

.

가

가

.

.

.

.

가

가 가

## 2. 일자리 협력망 구축 및 활성화

가  
- NGO- 가  
가

NGO

가  
가

-NGO-

가

### 3. 종합정보체계 구축

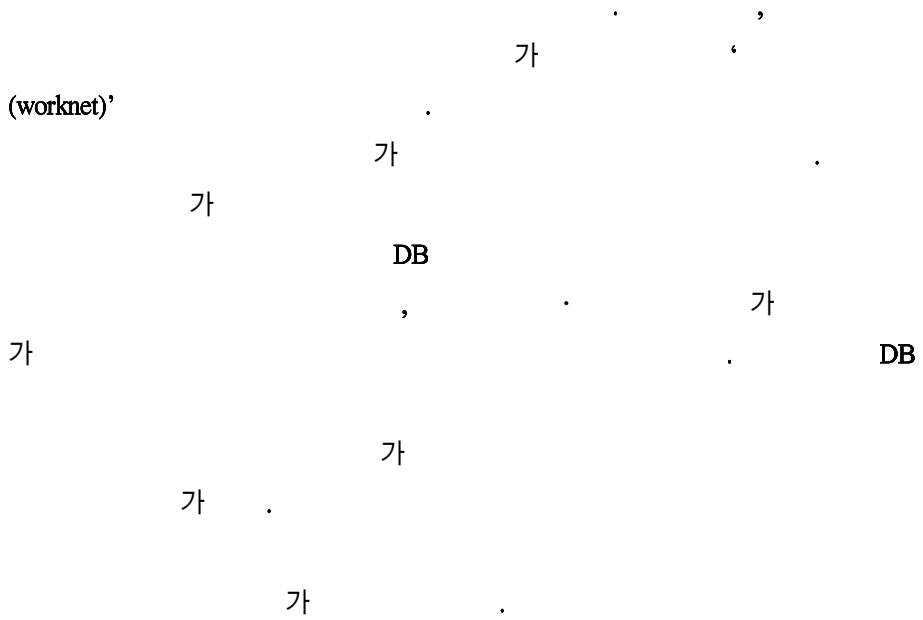

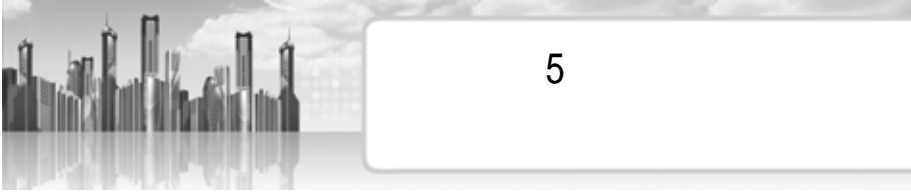

1



가 . 가

. .

.

.

.

,

,

.

.

.

,

,

,

,

.

.

,

,

,

,

,

.

.

가

.

.

가

,

4가

.

,

.

,

가

가

.

,

.

,

가

,

-

가

.

가

## 2



### 1. 지방자치단체 일자리창출 역할강화

가 .

,

가 .

가

,

.

가 .

### 2. 일자리창출의 효과성 제고

가

.



가 .  
 가 가 .  
 , , ,  
 가

.  
 가 .

.  
 .  
 Buy Local  
 가  
 .

### 3. 일자리창출과 연계한 재정지원

.  
 .  
 .  
 가 .  
 가  
 가 ,  
 .

가 . ,  
 ,  
 가 .

#### 4. 입자리창출 추진체계 구축

가  
 가 .  
 .  
 DB .  
 가  
 , , DB  
 가 .

< 5-1>

1.	1.1	- , , - ,
	1.2	- , , , - , / ,
	1.3	- -

		< >
2.	2.1 ( )	- 가 , - , ,
	2.2	- - - (Buy local)
3.	3.1	- - -
	3.2	- -
4.	4.1	- - ( . / )
	4.2	- /NGO/
	4.3	- - DB



, Policy Brief, No.9,  
 2009.3  
 , 2009.2.19  
 , 2007  
 (a), :  
 , 2009.4  
 (b), 2009 1 가 , 2009.4  
 (c), : , 2009.2  
 (d), , 2009.4  
 , 가, 2006.12  
 , , 2004.10  
 , , 10 , 2 ,  
 1998  
 , ( )  
 ), , Vol.2,  
 , 2000  
 , ( ) · , 2002  
 , : ,  
 , 2007.3  
 , ,

1997.

· , “ 가?”, 2 1 ,

2009

· “ ”, , 14

· , 2009

· : ,

· , Vol.37, No.1, , 2003

· , CEO information, 2009.2.11

· ‘ ’ , Issue Paper,

2009.3.16

· 3 , Issue Paper, 2009.3.23

· , CEO information, 2009.4.1

· , SERI 246 ,

2009.6.9

· 가

· , Vol.12, No.2, , 2007.

· , 2009

· , , 10 2

· , 2008,

· “ : .

· ”,

· , 2009.4.30

· ,

· , Vol.6, No.2, , 1998

· -AHP

· -, , 12 4 , 2002

· 가 ,

- , Vol15, No.2, , 2002
- , Vol.6, No.2, , 2004
- , 20 3 ,  
, 2007
- , ‘ (1.6)  
, 2004 가, 2006
- , , 2007
- , , 2004
- OECD, Labour Market Policies and Public Employment Service, 2001.
- OECD, Employment Outlook, 2006.
- R.A.Musgrave & P.B. Musgrave, Public finance in theory and Practice,  
Singapore:McGraw-Hill Book Co., 1992
- Shah, Anwar, The Reform of Intergovernmental Fiscal Relations in Developing and  
Emerging Market Economy, Washington D.C.: The World Bank, 1994.
- White House, Roadmap to Recovery, June 2009
- <http://www.forbes.com/2009/04/14/cities-city-top-lifestyle-real-estate-cities-united-states.html>

**Abstract**

## A Study on Strengthening the Role of Local Government in Job Creation

In recognition of the importance of the role of local governments on local job creation, this study investigated what local governments must do and the efficient method as well as financial support and its management plan in order to strengthen the role of local governments.

Most of the countries throughout the world create direct jobs through the government sector by expanding the budget, and create new jobs by providing new public services such as social services, and at the same time sustain them by supporting companies. Moreover, it is planning the mid-long term projects for green growth and new growth engines in terms of the paradigm shift in economy and society, and planning future job creation by investing resources through this. Since the government's job creation policy is finally implemented in local areas, the role of local governments on job creation is significant. However, in the case of Korea, the central government has established a plan on regional development policy or job creation, while local governments have only been responsible for its implementation, therefore the role of local governments was not considered important.

The process of this study is as follows.

- (1) Firstly, theories on job creation and overseas recent case studies : The theories include the concept of job creation and the role of local governments on job creation while the overseas recent case studies contain the job creation policy of the Obama administration in the US, Japan's recent employment measures

and the central government's financial support, and Britain's trends on job creation.

- (2) Secondly, chronological transition on Korea's job creation policies and the current status and problems of the current administration's core policies on job creation such as Green New Deal, employment measures through the budget, public employment project, Green jobs creation, and social employment scheme: This part explores the problems and limits in promoting local governments' job creation projects rather than the issues of an individual project on the job creation policy in Korea, because local governments have a crucial role in promoting the job creation project and it needs to look over inadequate or necessary functions.

The reasons why local governments were not able to take on a role in creating jobs locally are condensed into four types.

- (1) Firstly, the central government has controlled the plan and implementation on the job creation.
- (2) Secondly, the project failed in creating jobs according to the features of each region and custom job creation, the local infrastructure or living conditions were more focused instead, and it resulted in unstable jobs due to the failure of the custom job creation project.
- (3) Thirdly, a specific project was promoted as a secondary effect but further financial support related to job creation was not provided.
- (4) Lastly, as there is no job creation organization performance measurement on local job creation was not managed, and government-private sector cooperation system on a job creation project was not established well. Besides, information relevant to job creation was managed and provided by the central instead of local governments.



In conclusion, in order to promote the job creation efficiently this study proposes that local governments need to strengthen the job creation related functions and promote a project considering local characteristics. Moreover, financial support coupled with job creation is to be provided and at the same time, organizations and information systems are to be established to promote the project.



---

: 2009 12 31

:

:

43

Tel : 02)3488 - 7300

:

Tel. 02)394 - 0337

<http://www.gpcbooks.co.kr>

: ( )

Tel. 02)2274 - 7800

---

ISBN 978-89-7865-337-4